

LOYDS SMARTFLOOR

Isuzu D-Max Installation Manual



Manual nr 15020560 Rev01
Loyds Industri AS 2022-02-07



Revision Record

Rev nr	Date	Page	Picture	Update	New	Deleted steps
01	07.02	5		15020133 SF D-Max Bracket Set	C2=C4, C3=C5, C4=C2, C5=C3	

Recommended torque for screws:

4,2mm Selfdrilling: 3,6 NM
 6mm: 6 NM
 8mm: 10 NM
 10mm: 42 NM

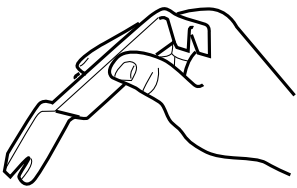
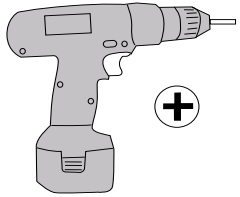
Tools

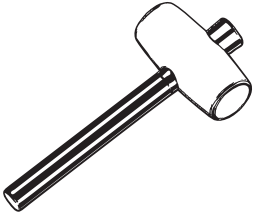
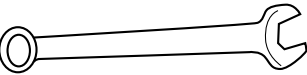
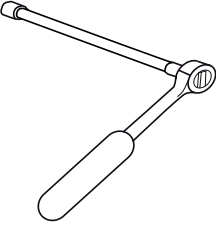
			
10-13 mm 	10-13 mm 	Torx Bits TX 20 TX 25 TX 30	

15020557 Kit Complete SF Isuzu D-Max

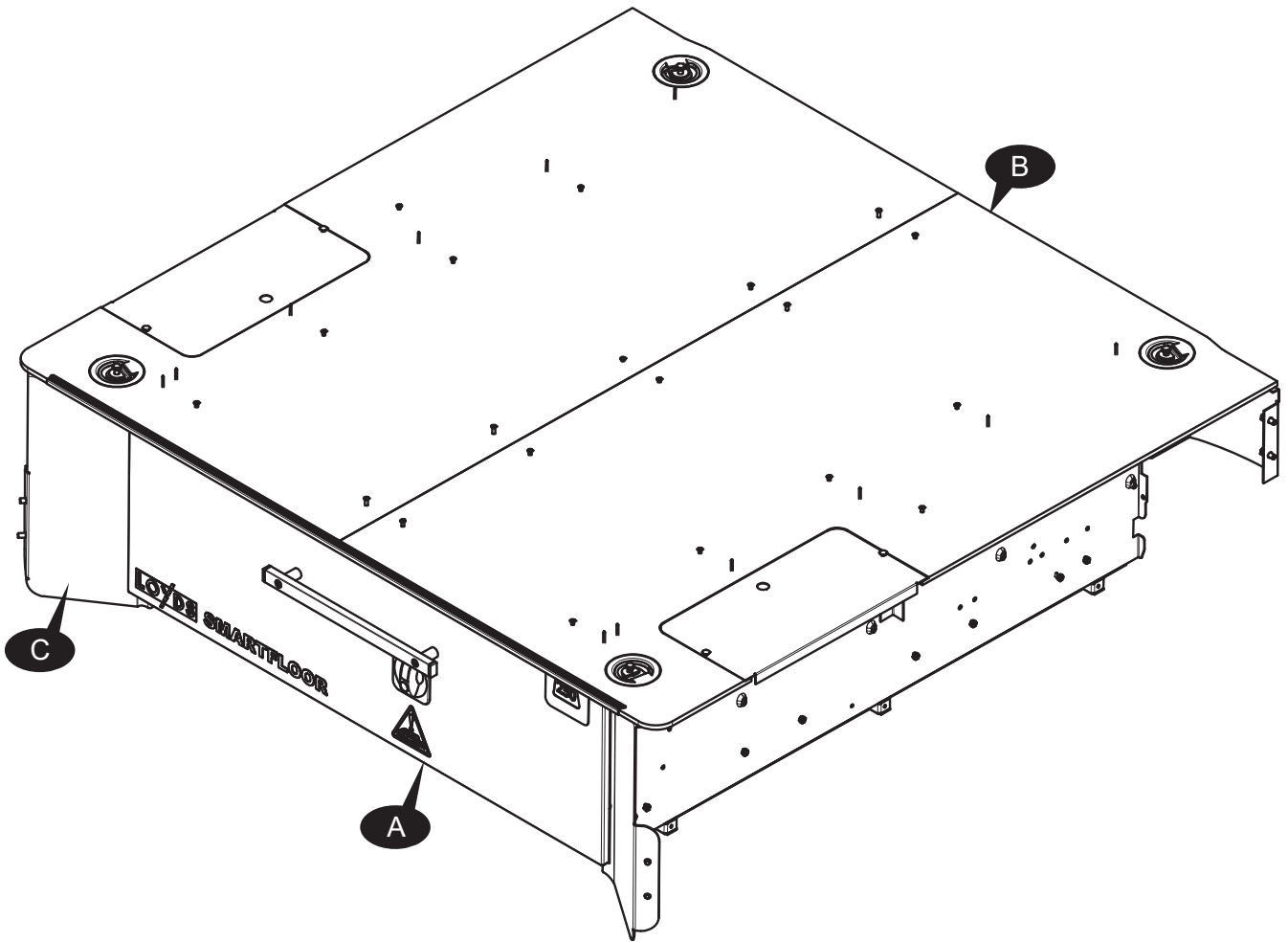

Item	Quantity	Part Number	Description
A	1	15010859	RD Drawer 1000 1200 Main Assy
B	1	15020139	SF D-Max Floor ASSY
C	1	15020133	SF D-Max Bracket Set

15020139 SF D-Max Floor ASSY

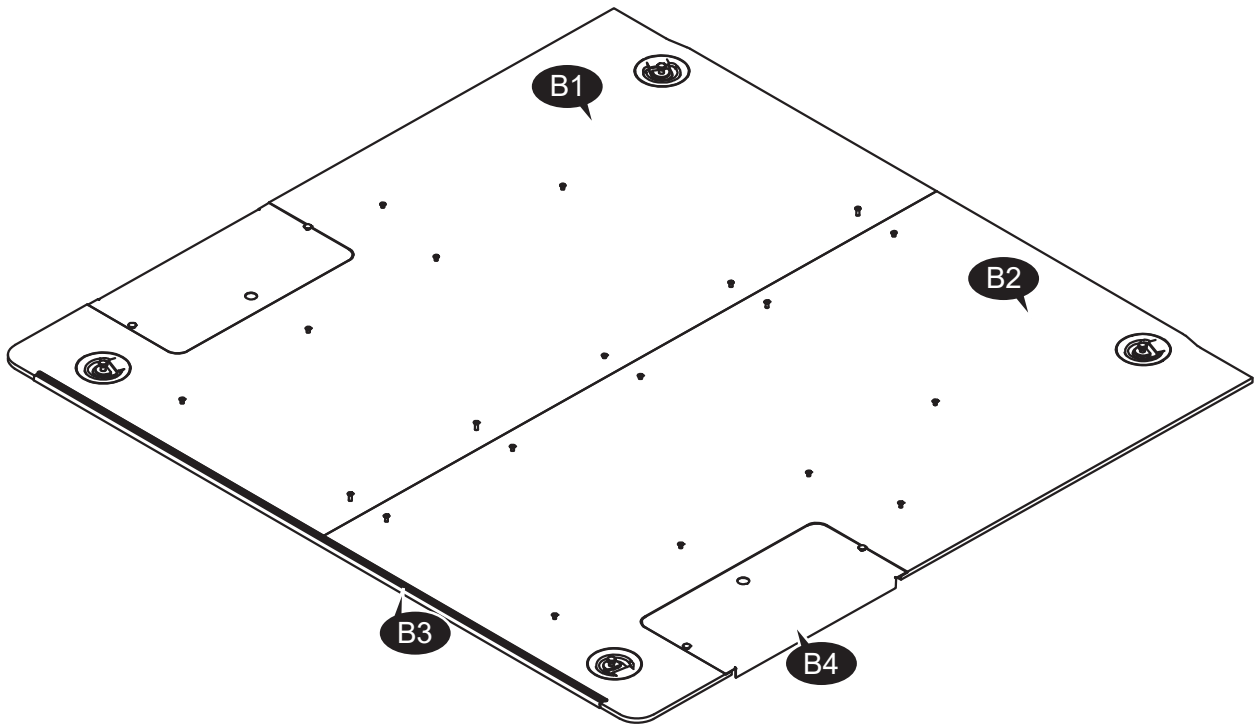

15012645 Floor Set Hilux D-cab

Item	Quantity	Part Number	Description
B1	1	15020137	SF D-Max Floor Left
B2	1	15020138	SF D-Max Floor Right
B3	1	15027301	U-Profile 9mm L=1345
B4	2	15020008	Hatch Floor Box
	1	15020556	Fitting Kit Floor Set Isuzu D-Max

15020133 SF D-Max Bracket Set

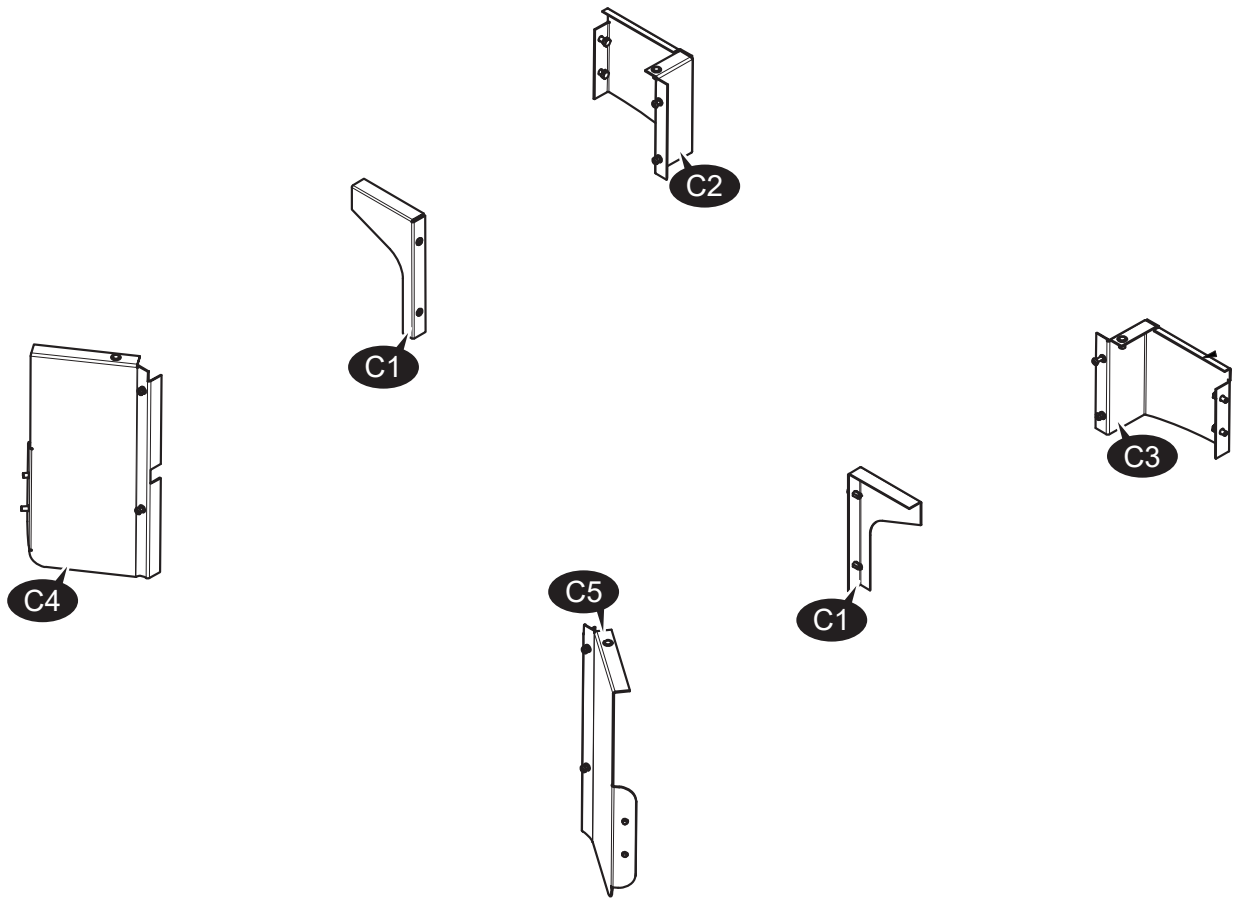

Item	Quantity	Part Number	Description
C1	2	15018463	Bracket Floor Stiffner 150mm ASSY
C2	1	15020126	SF D-Max Bracket Front Left ASSY
C3	1	15020128	SF D-Max Bracket Front Right ASSY
C4	1	15020130	SF D-Max Bracket Rear Left ASSY
C5	1	15020132	SF D-Max Bracket Rear Right ASSY
	1	15020555	Fitting Kit Bracket Set Isuzu D-Max

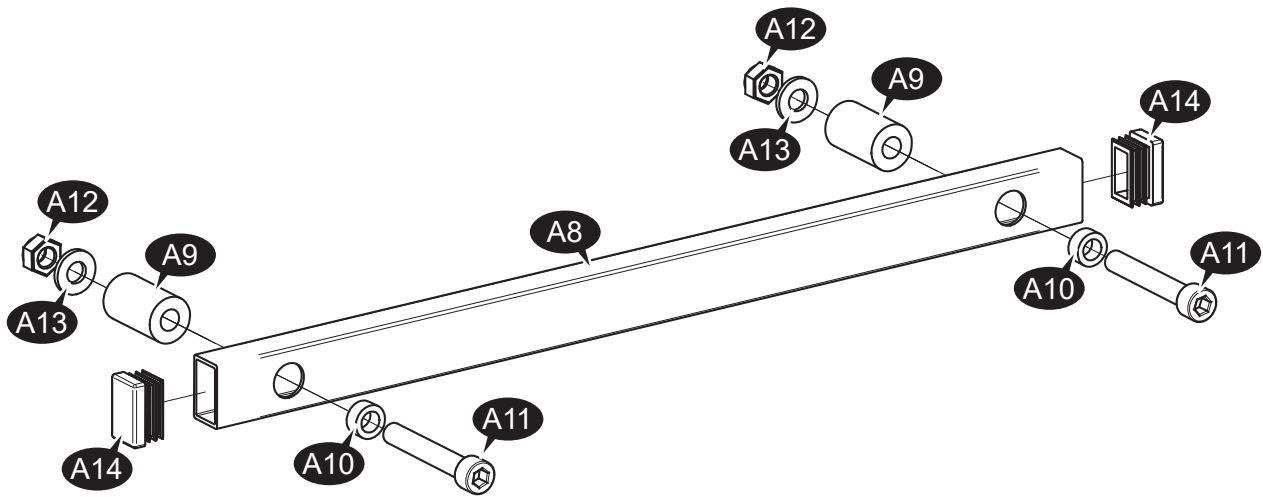

15010236 Handle Assy



15010236 Handle Assy

Item	Quantity	Part Number	Description
A8	1	15009441	Handle Tube 25x15x286
A9	2	15009442	Spacer Ø8,3x18x30 Nylon Black
A10	2	15009443	Spacer Ø8,1x13x6mm Galv
A11	2	15009444	Screw M8x50 Cylinderh Hex
A12	2	8 NMU	Mutter M8 Nyloc DIN985
A13	2	8,4x17x2	M8 Washer, DIN 125
A14	2	15009438	End Plug Tube 25x15 Inside

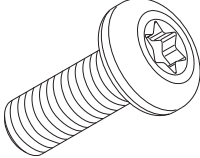
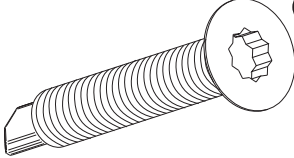
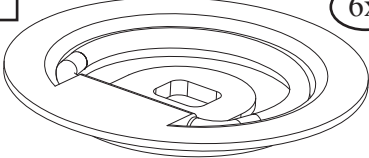
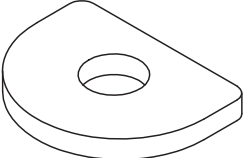
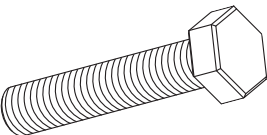
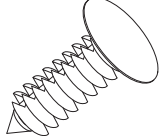
Fitting Kit

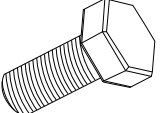
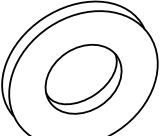
F1 22x  15003551 M6x16 TX30 pan (DIN 7985)	F2 24x  15009568 Screw 4,8x32 Selfdrill Counters Torx Elz	F3 6x  15005497 Latch Cup Black Ø90 Ø12x15 1000Kp
F4 6x  15005884 Washer Latchcup for Ø8	F5 6x  8x40 M8x40mm Bolt, DIN 933, sort	F6 2x  Sort Plastpropp
F7 6x  225 085 6516 Gummikloss 12x12x5 sort m tape	F8 8x  8x20 6K 8x20 6K NS1824, Elz 8.8 Din 933	F9 8x  8,4x17x2 M8 Washer, DIN 125
F10	F11	F12
F13	F14	F15
F16	F17	F18
F19	F20	F21



= Keep the part.



= You dont need this part in the insatalltion.

The number indicates the refferance to the part, later in the manual.

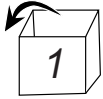

= Use a part that you've dismantled earlier.

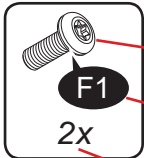

- Picture of part

- Refferance to Fitting Kit

- Quantity that will be used at the current step

Orientation Symbols

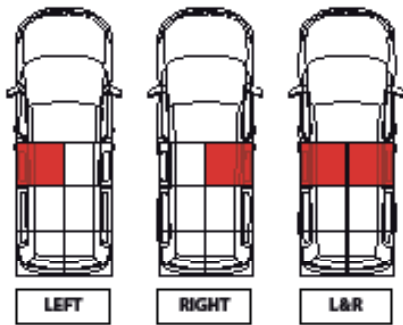

Front

Left and Right (L&R) indicates that the assembly is equal or close to equal on both sides.

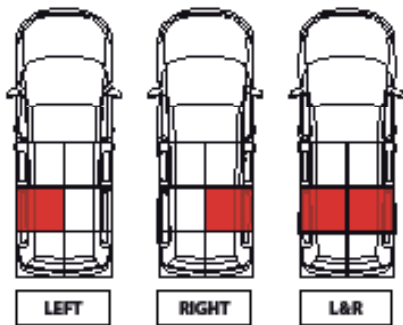

Middle

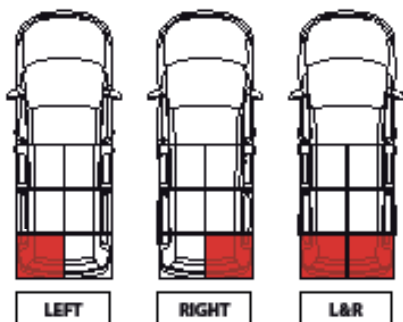

Rear

1.

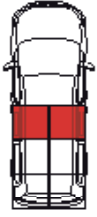

L&R

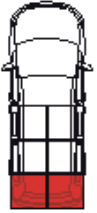

L&R

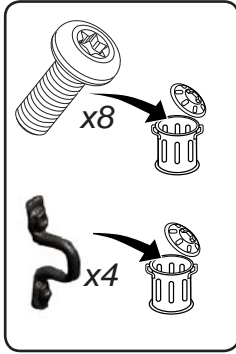

2.

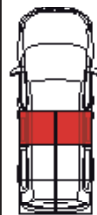

L&R

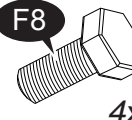
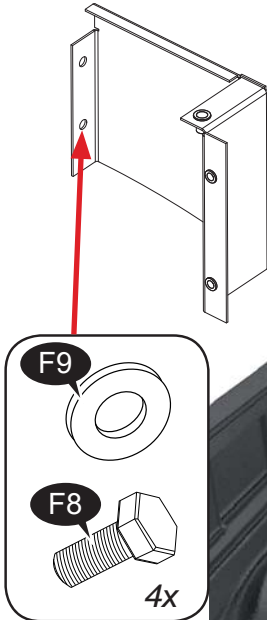

4x



3.

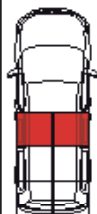

L&R

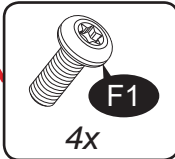

4x

4.

Left Right

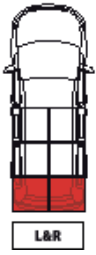
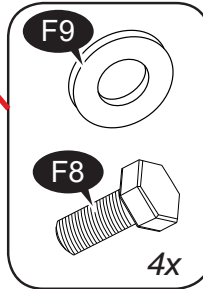
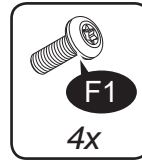
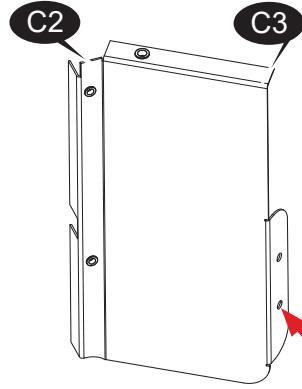

5.

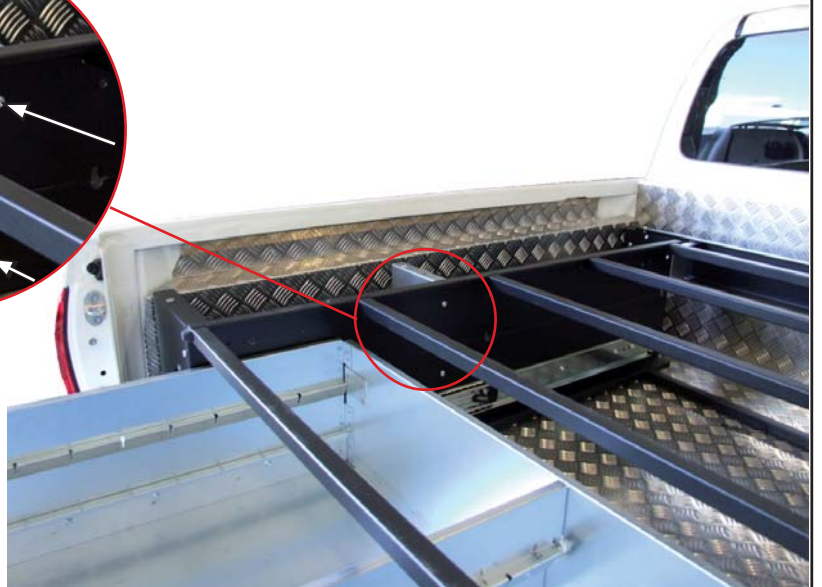
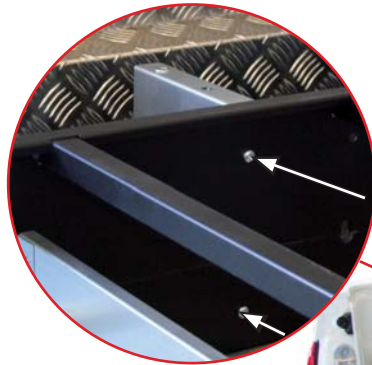
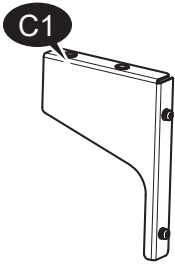

6.

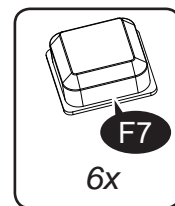

7.

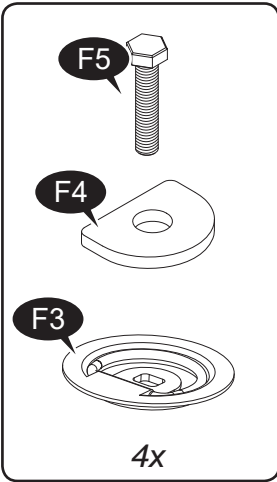
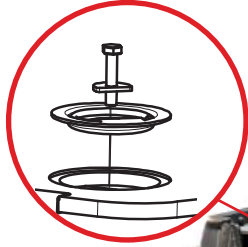

8.

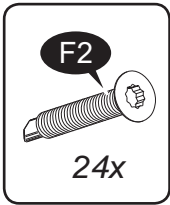
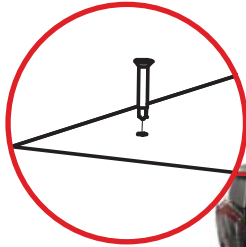

9.

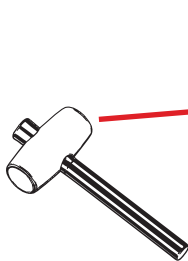

10.

