

SMARTFLOOR

Ford Courier 2024 Installation Manual



Manual nr 15026258 Rev0
Loyds Industri AS 02-07-2024



Revision Record

Rev nr	Date	Page	Picture	Update	New	Deleted steps

Recommended torque for screws:

4,2mm Selfdrilling: 3,6 NM
 6mm: 6 NM
 8mm: 10 NM
 10mm: 42 NM

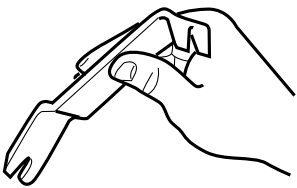
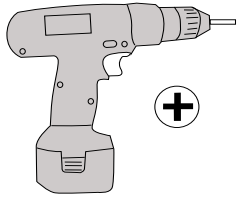
Tools

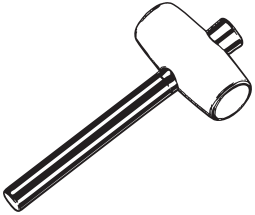
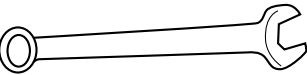
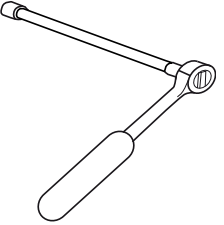
			
10-13 mm 	10-13 mm 	Torx Bits TX 20 TX 25 TX 30	

15026070 Kit Clomplete SF Ford Courier

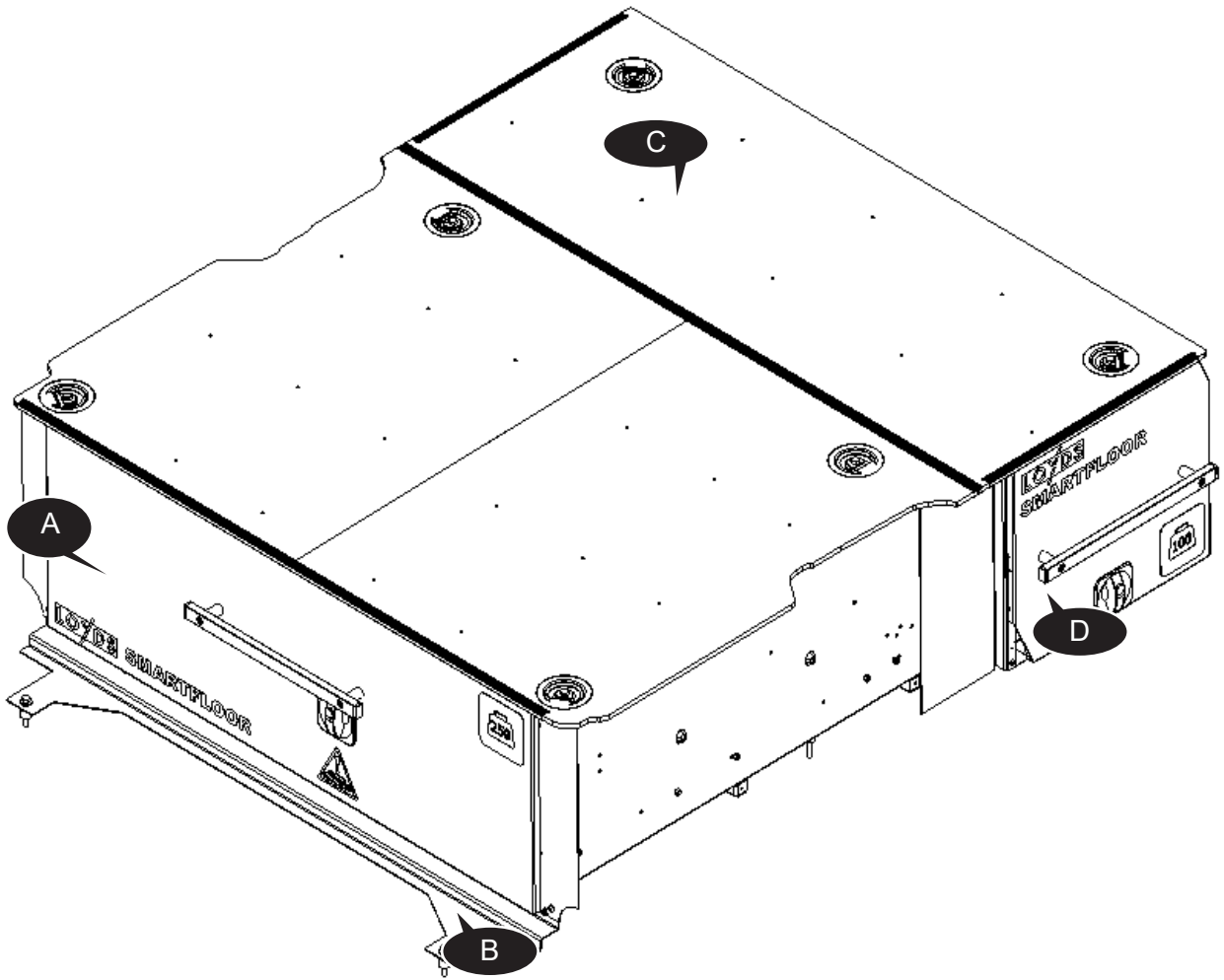

Item	Quantity	Part Number	Description
A	1	15020679	SF Rear Drawer W1000 L900 ASSY
B	1	15026246	Steel Bracket set Ford Courier
C	1	15026084	Wooden Floor Kit Ford Courier
D	1	15010862	FD2 Front Drawer 400-600 Complete Assy

15026084 Wooden Floor Kit Courier

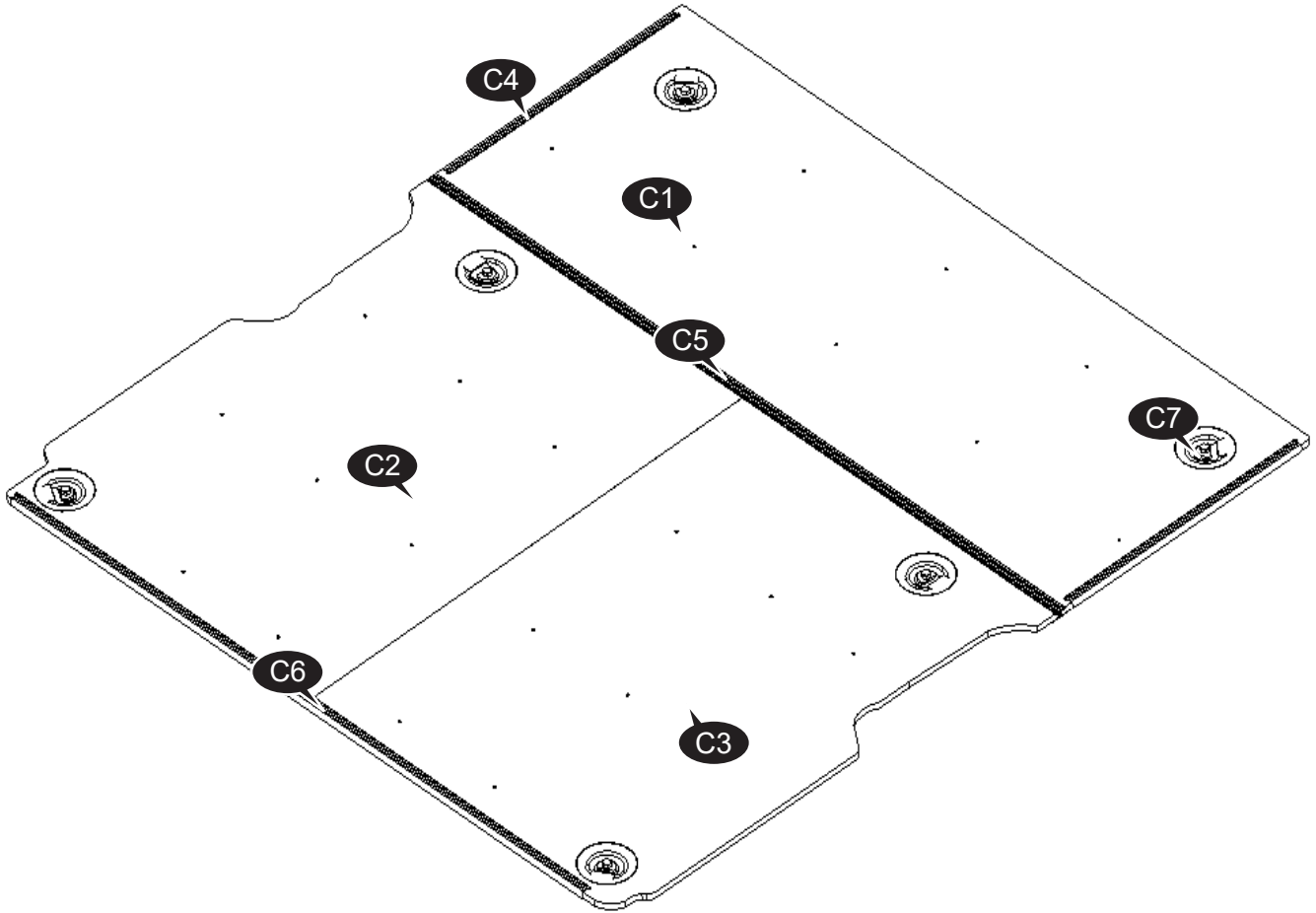

15026084 Floor Kit Set Courier

Item	Quantity	Part Number	Description
C1	1	15026082	Floor Front Courier 9mm
C2	1	15026091	Floor Rear Left Courier 9mm
C3	1	15026089	Floor Rear Right Courier 9mm
C4	2	15026087	U-profile 9mm L=480
C5	1	15026085	H-profile 9mm L=1327
C6	1	15026089	U-profile 9mm L=1204
C7	6	15026090	Fitting Kit Floor Set Courier

15026246 Steel Bracket Set Ford Courier

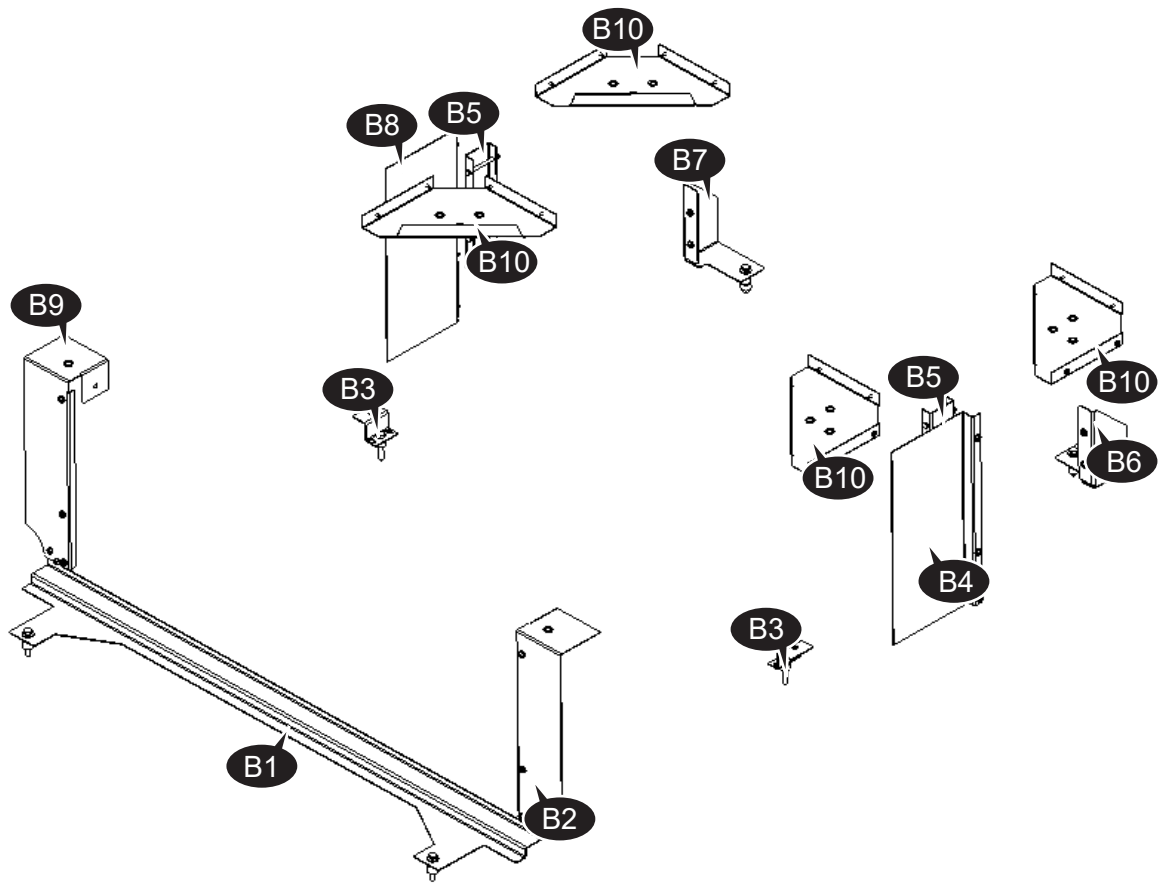

Item	Quantity	Part Number	Description
B1	1	15026240	Bracket Rear Lower SF Courier
B2	1	15026238	Bracket Rear Right SF Courier
B3	2	15026234	Bracket Middel SF Courier
B4	1	15026080	Cover Courier Right
B5	2	15011036	Distande Profile FD RD Caddy Short
B6	1	15026233	Bracket Front Right SF Courier
B7	1	15026231	Bracket Front Left SF Courier
B8	1	15026078	Cover Courier Left
B9	1	15026236	Bracket Rear Left SF Courier
B10	4	15018460	Bracket Latch Inner 8mm

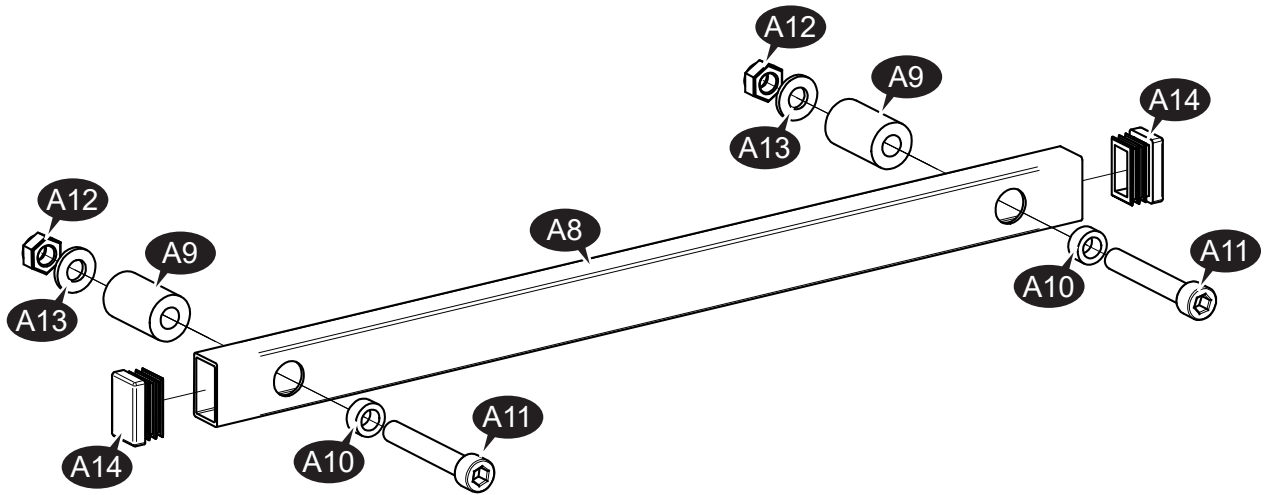

15010236 Handle Assy



15010236 Handle Assy

Item	Quantity	Part Number	Description
A8	1	15009441	Handle Tube 25x15x286
A9	2	15009442	Spacer Ø8,3x18x30 Nylon Black
A10	2	15009443	Spacer Ø8,1x13x6mm Galv
A11	2	15009444	Screw M8x50 Cylinderh Hex
A12	2	8 NMU	Mutter M8 Nyloc DIN985
A13	2	8,4x17x2	M8 Washer, DIN 125
A14	2	15009438	End Plug Tube 25x15 Inside

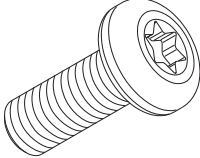
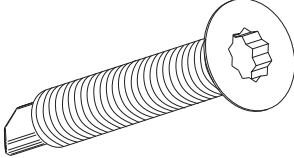
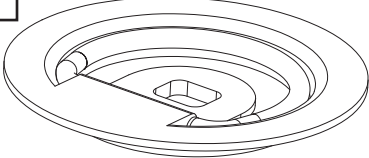
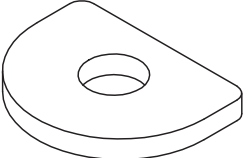
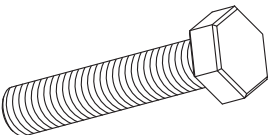
Fitting Kit

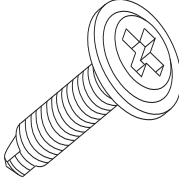
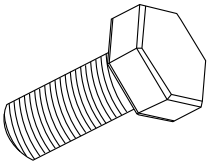
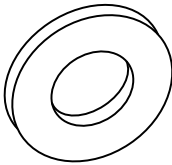
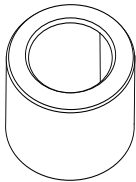
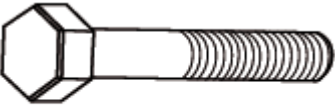
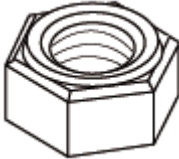
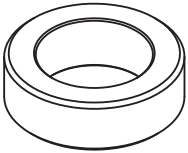
<p>F1</p>  <p>15003551 M6x16 TX30 pan (DIN 7985)</p>	<p>F2</p>  <p>15016947 Screw 4,8x25 Selfdrill Counters Torx</p>	<p>F3</p>  <p>15005497 Latch Cup Black Ø90 Ø12x15 1000Kp</p>
<p>F4</p>  <p>15005884 Washer Latchcup for Ø8</p>	<p>F5</p>  <p>15004713 M8x50 Screw, 6K DIN 933 Elz, sort</p>	<p>F6</p>  <p>13x20x6,4</p>
<p>F7</p>  <p>4,2x16 FL Platescrew selftapping BLANK Elz</p>	<p>F8</p>  <p>8x25 6K M8x25 6K Elz 8.8 Din 933</p>	<p>F9</p>  <p>10,5x20x2 M10 Washer, DIN 125 A4</p>
<p>F10</p>  <p>15001584 Distance Sleeve D20 d13 h15</p>	<p>F11</p>  <p>6x70 Delgjenget Hex-head bolt elzn</p>	<p>F12</p>  <p>6 NMU M6 Self locking nut, DIN 985-8</p>
<p>F13</p>  <p>13X20X6,4 Spacer, U-709</p>	<p>F14</p>	<p>F15</p>
<p>F16</p>	<p>F17</p>	<p>F18</p>
<p>F19</p>	<p>F20</p>	<p>F21</p>

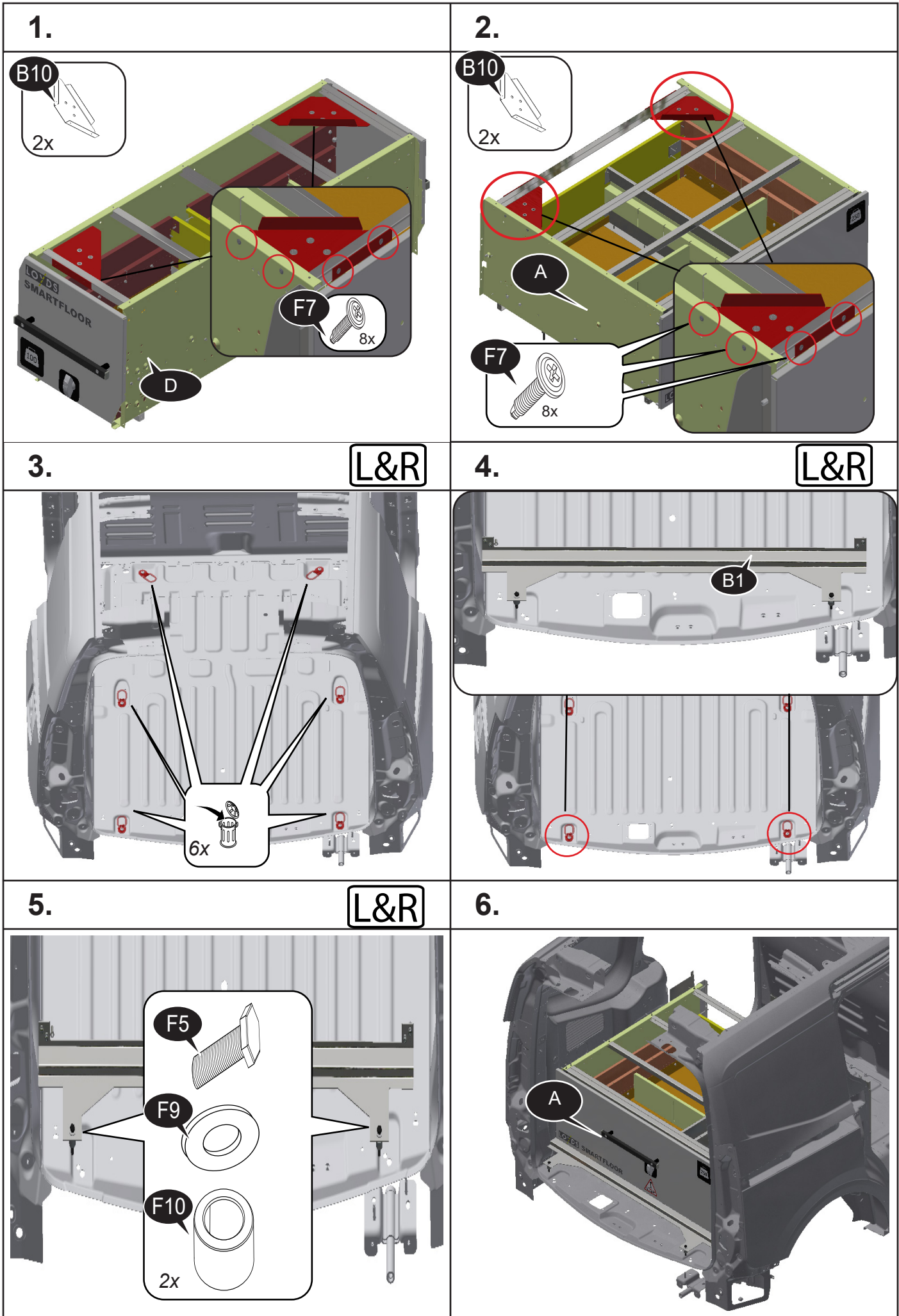

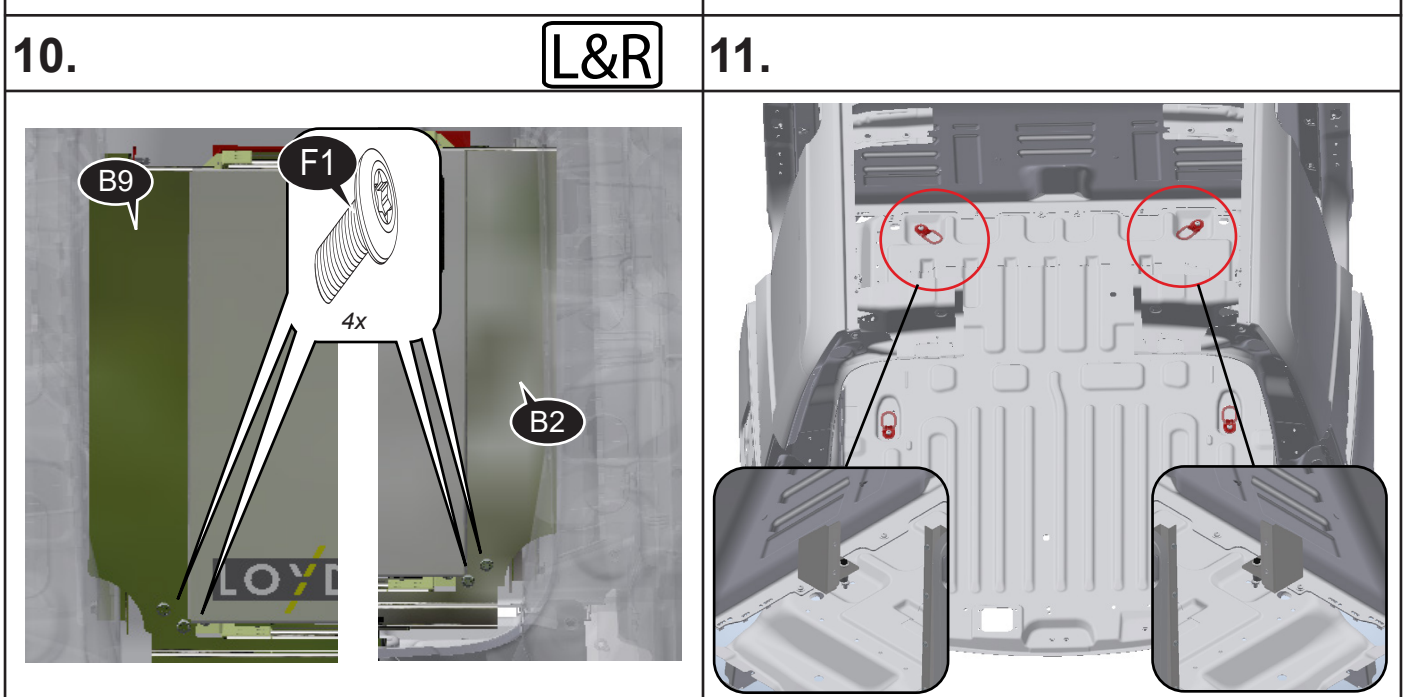
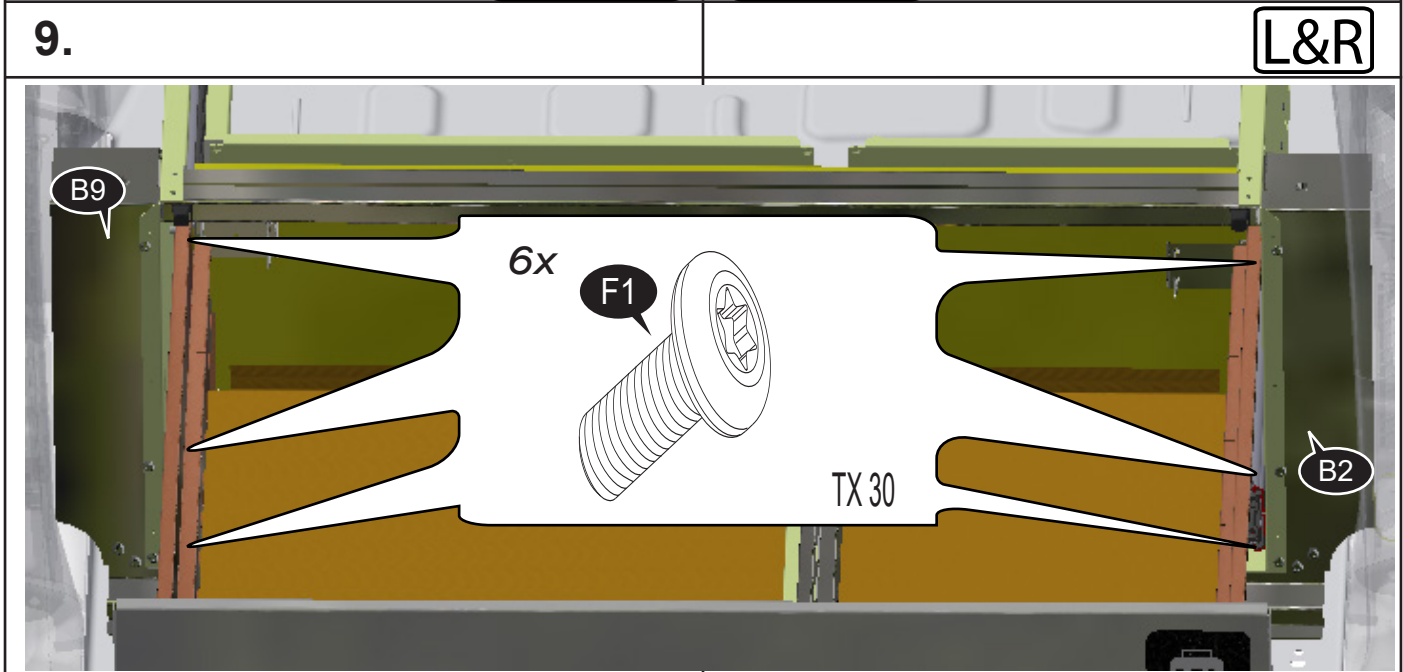
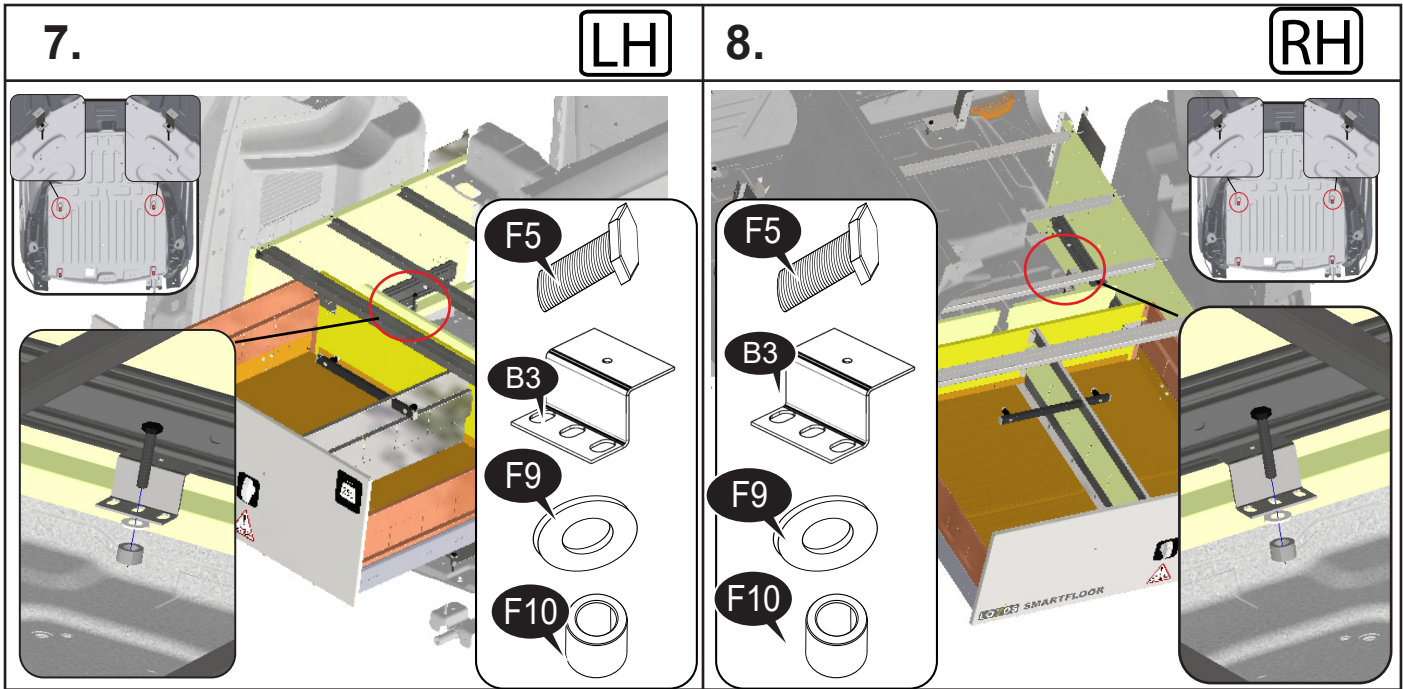

12.

L&R

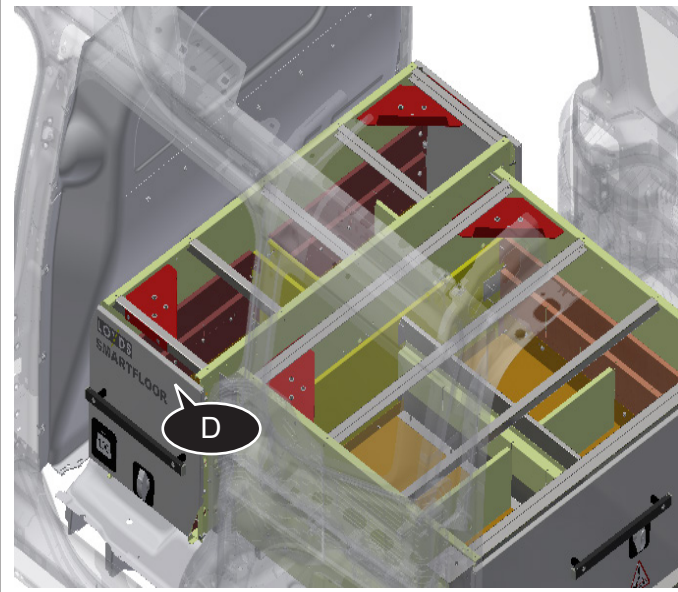

13.

LH

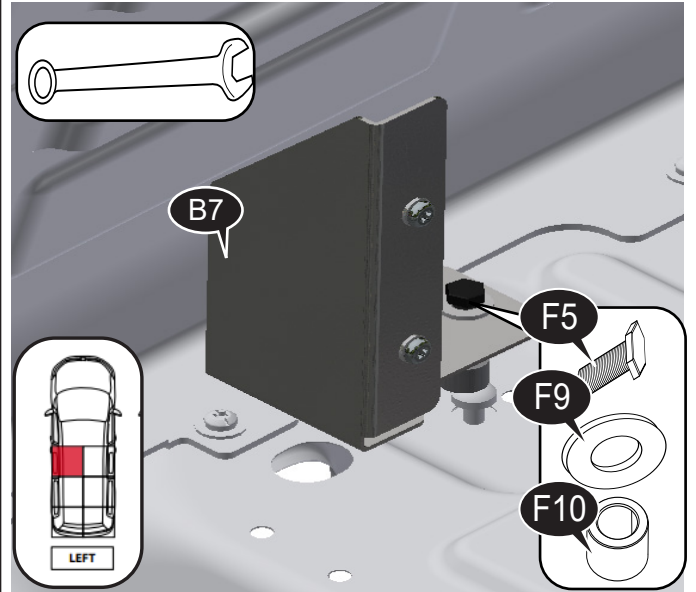

14.

RH

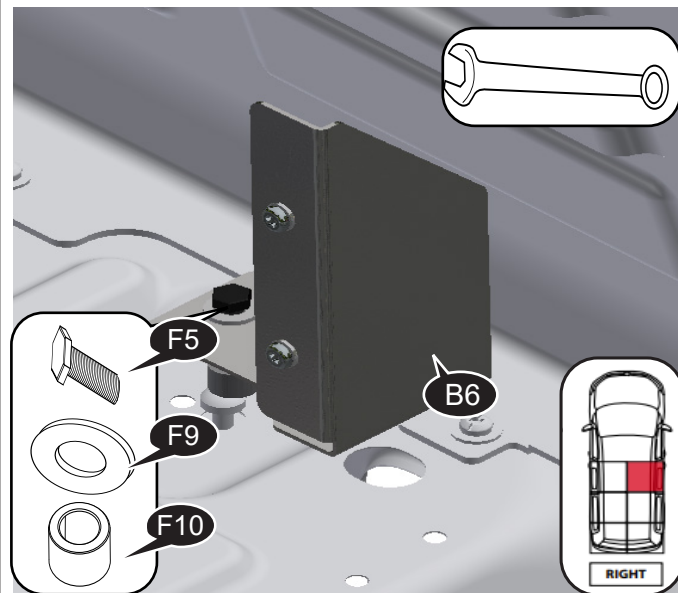

15.

RH

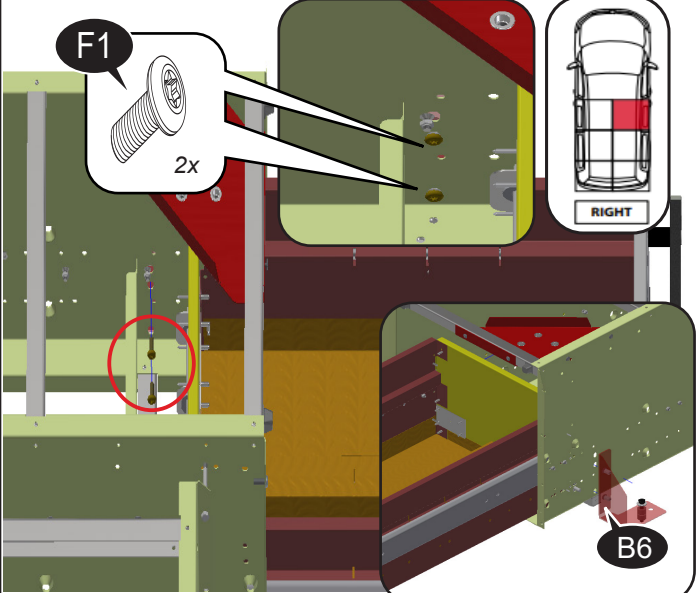

16.

LH

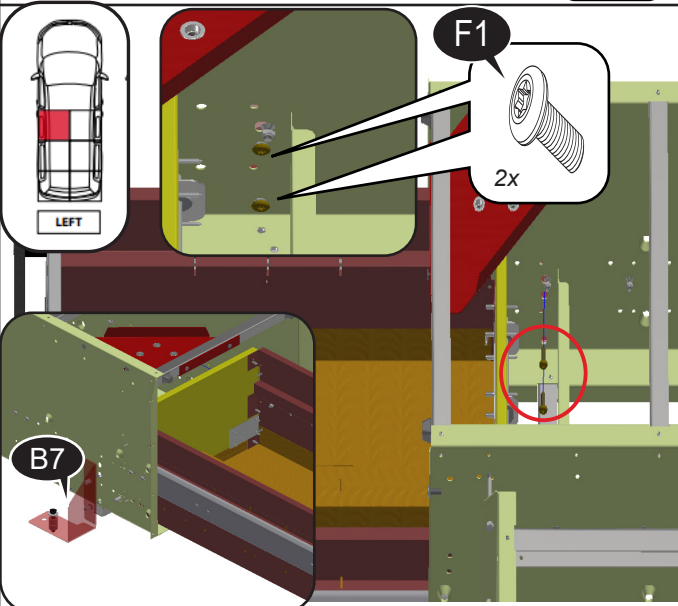

17.

LH

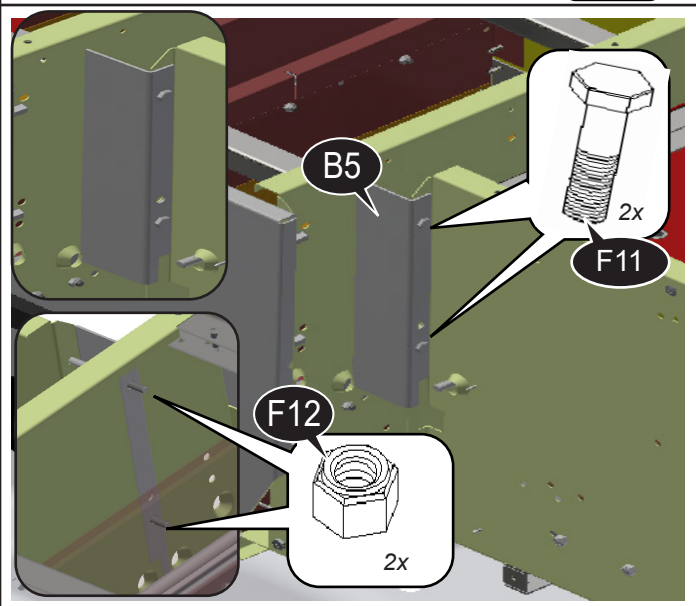

18.

RH

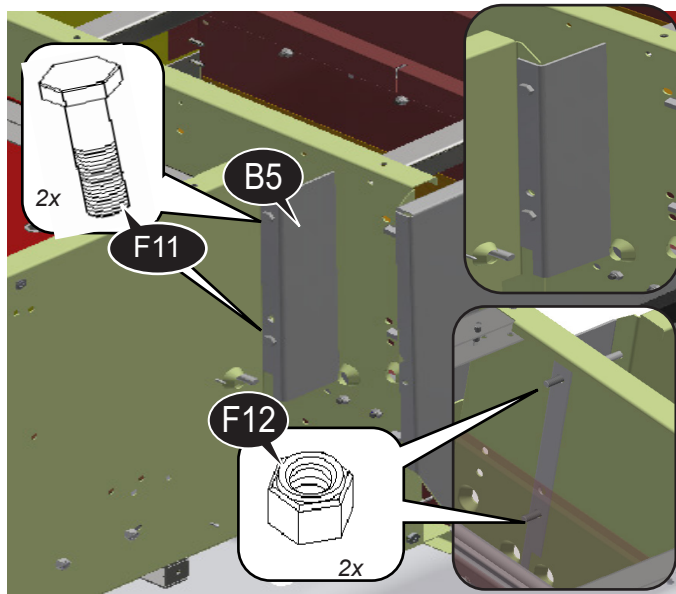

19.

RH

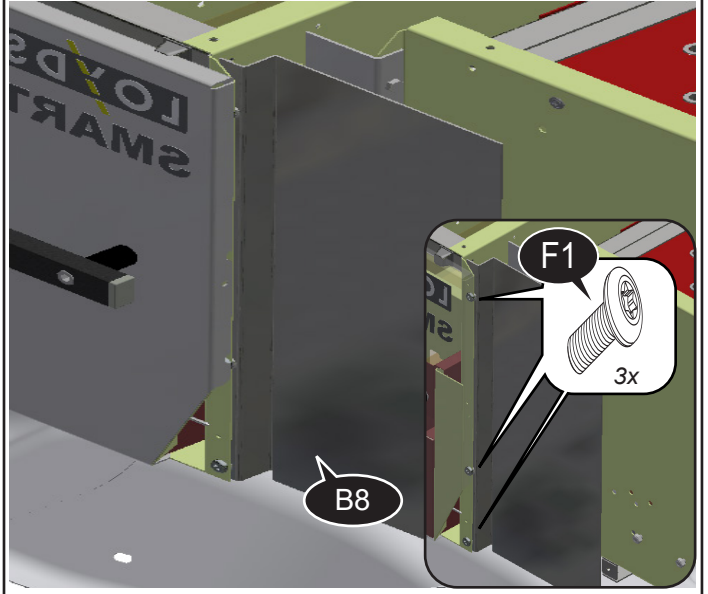

20.

LH

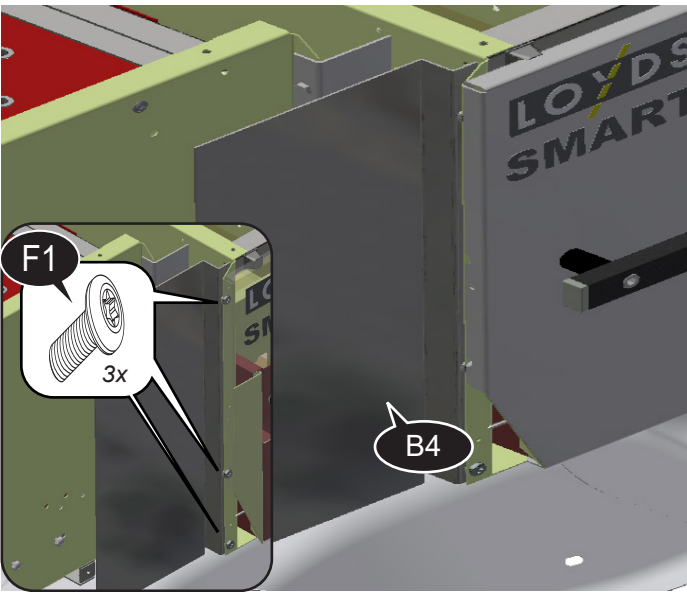

21.

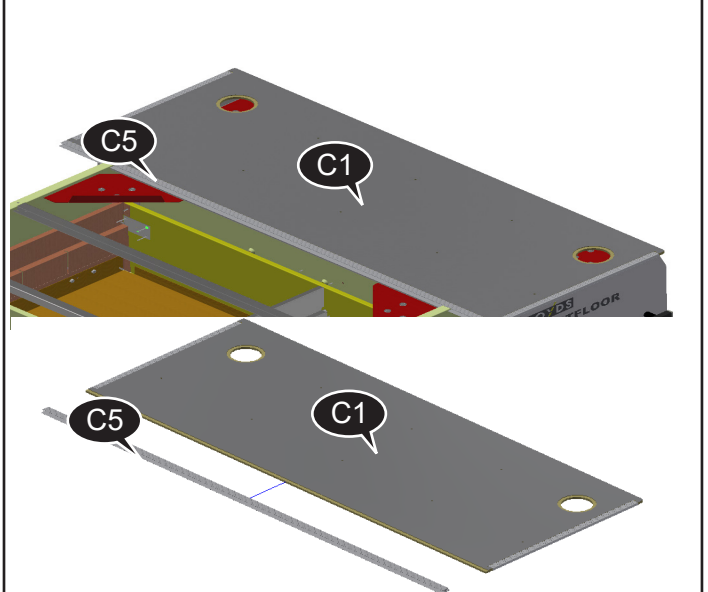

22.

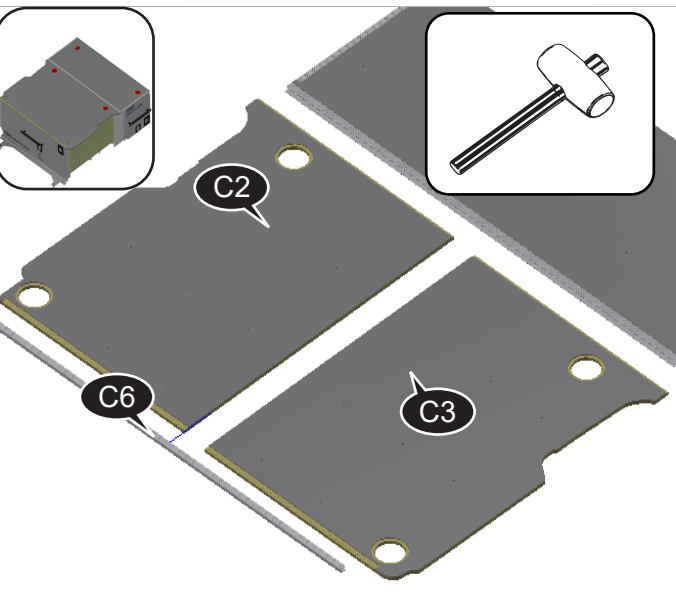

23.

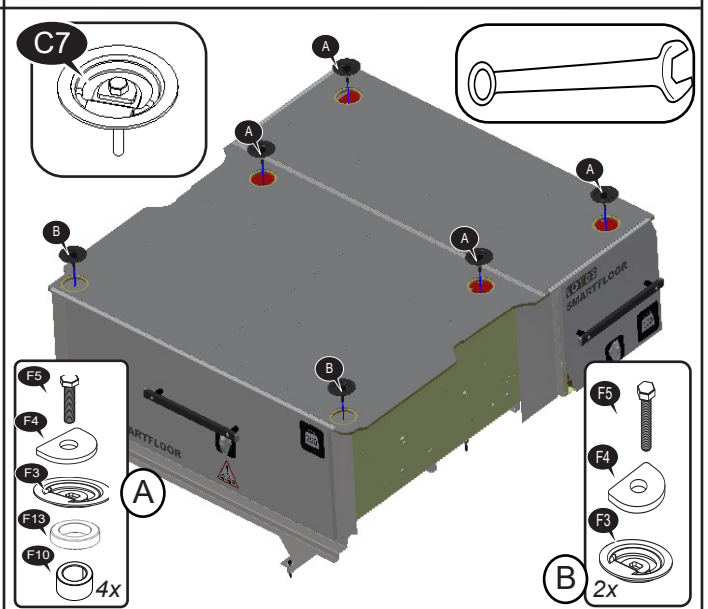

24.

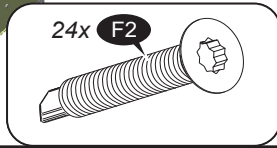
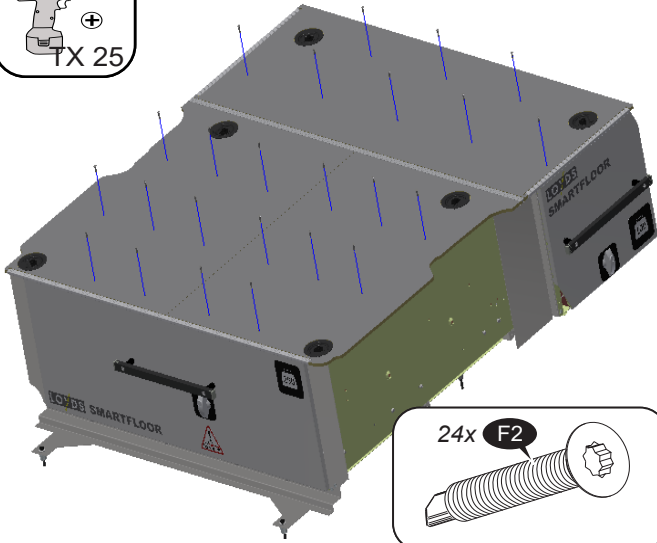
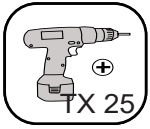

25.

