

# SMARTFLOOR **ACCESSORIES**

## Stepladder Kit

# INSTALLATION MANUAL



**15022091 Stepladder Kit Caddy 5**





# REVISION RECORD

Rev. nr.	Date	Page	Picture	Update	New	Deleted steps
B	2025-01-27	4 9		Removed 15022094  Updated B2 from 15021396 to 150220963		

## RECOMMENDED ATTRACTION MOMENTS SCREWS

4,2 mm selfdrilling	3,6 NM
5 mm	5 NM
6 mm	6 NM
8 mm	10 NM
10 mm	42 NM

## TOOLS

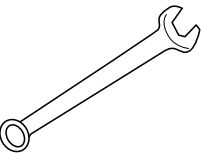
 Popnut tool (M5)		 TX20 TX30	 H5	 Threadlock (Würth H, Art. nr. 0893270050)
 10-13 mm				

# FITTING KIT

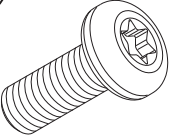
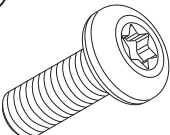
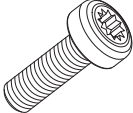
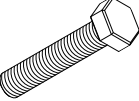
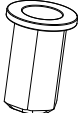
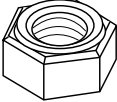
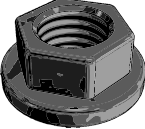
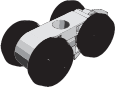
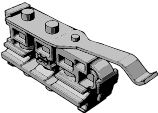
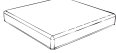
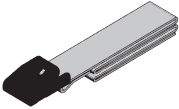
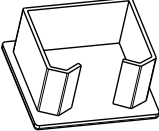
<p><b>F1</b></p>  <p><b>15007657</b> Screw M6x20</p>	<p><b>F2</b></p>  <p><b>15009448</b> Screw M6x12</p>	<p><b>F3</b></p>  <p><b>15004586</b> M5x20</p>	<p><b>F4</b></p>	<p><b>F5</b></p>
<p><b>F6</b></p>  <p><b>8x40 6k</b> Skrue 8x40 elz, 6k</p>	<p><b>F7</b></p>  <p><b>15004443</b> M5 Popnut Hex-body</p>	<p><b>F8</b></p>  <p><b>6 NMU</b> Nut M6 Nylock</p>	<p><b>F9</b></p>  <p><b>15015995</b> M8 Nut Flanged</p>	<p><b>F10</b></p>  <p><b>15014090</b> Stepladder Roller</p>
<p><b>F11</b></p>  <p><b>15015996</b> Retaining Stop</p>	<p><b>F12</b></p>  <p><b>15001779</b> 20x20x3 Cell Rubber</p>	<p><b>F13</b></p>  <p><b>15015982</b> Stepladder Strap</p>	<p><b>F14</b></p>  <p><b>15021410</b> Ende propp</p>	





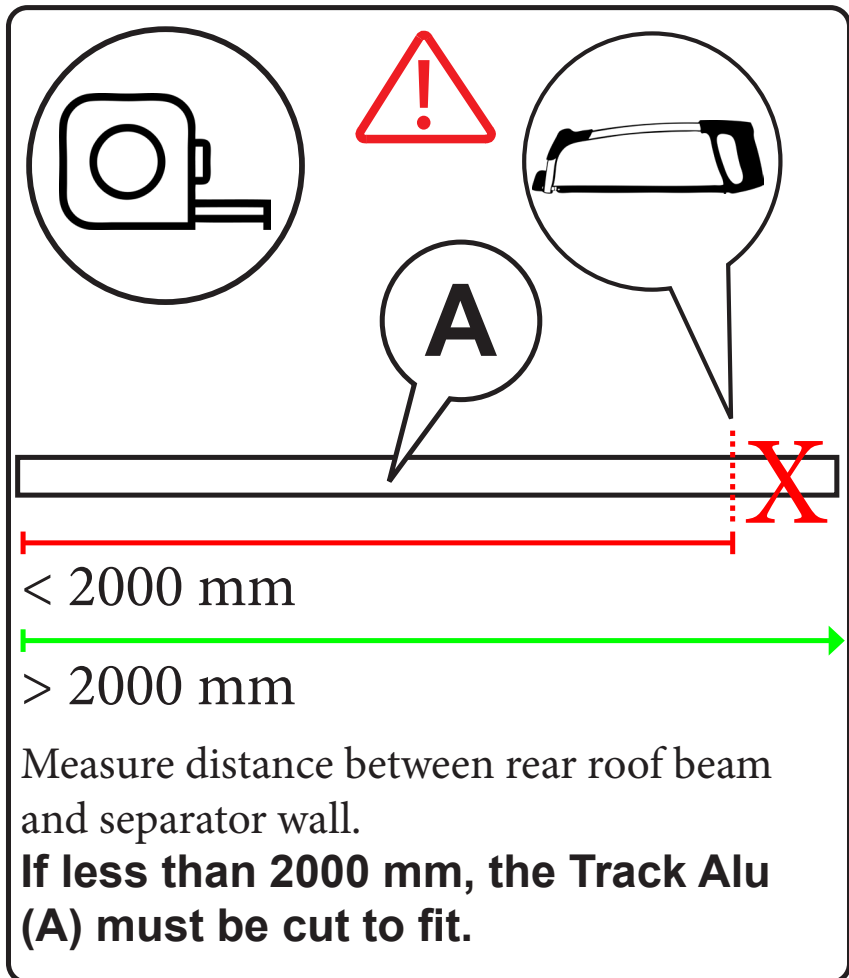

## 5.1 ADJUSTEMENTS - Ladder Bracket Rear

Front

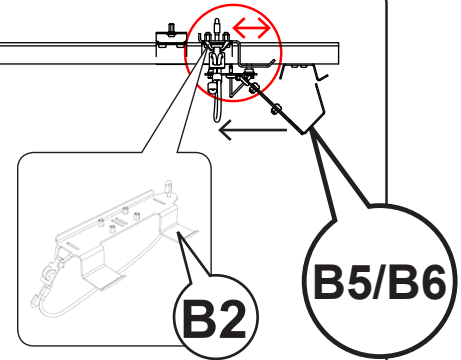
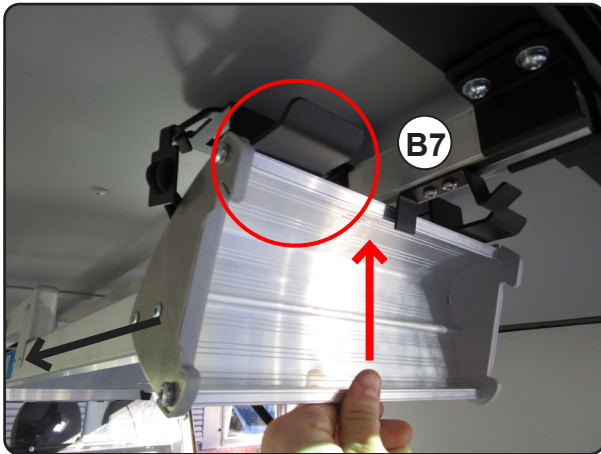

Hang stepladder in **Ladder Bracket Front** (B5/B6) and push it forward. Lift the top end of the stepladder and place it towards the **Ladder Stop Bracket** (B7). Set the **Ladder Bracket Rear** (B2) where it supports the top end of the stepladder.

## 5.2 ADJUSTEMENTS - Retaining Stop

Front

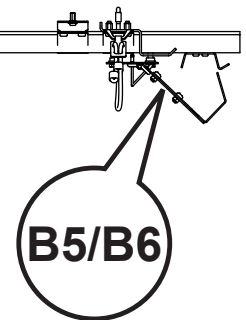
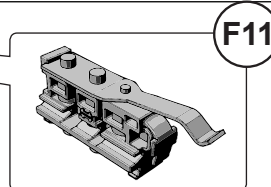
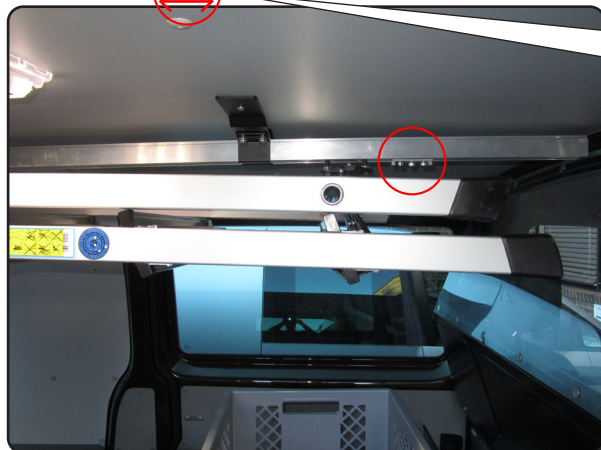

Slide the **Retaining Stop** (F11) towards the **Ladder Bracket Front** (B5/B6) until it locks onto the front roller. It can be necessary to adjust the front screw for it to lock on smoothly. Set the **Retaining Stop**.

## 5.3 ADJUSTEMENTS - Padding

Add **Cell Rubber** (F12) to areas where metal parts touch to eliminate noise from the kit.

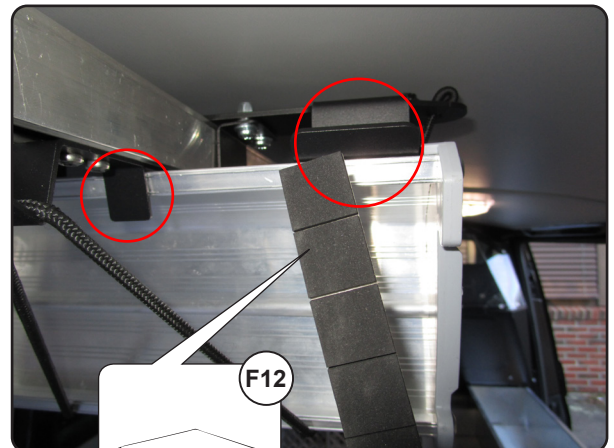
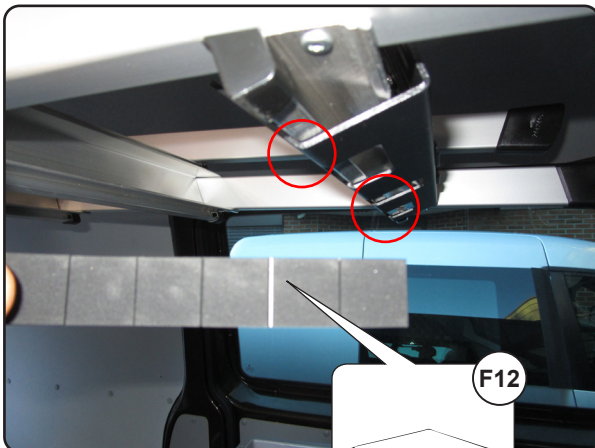

# 1 ROOF BRACKETS - preparations

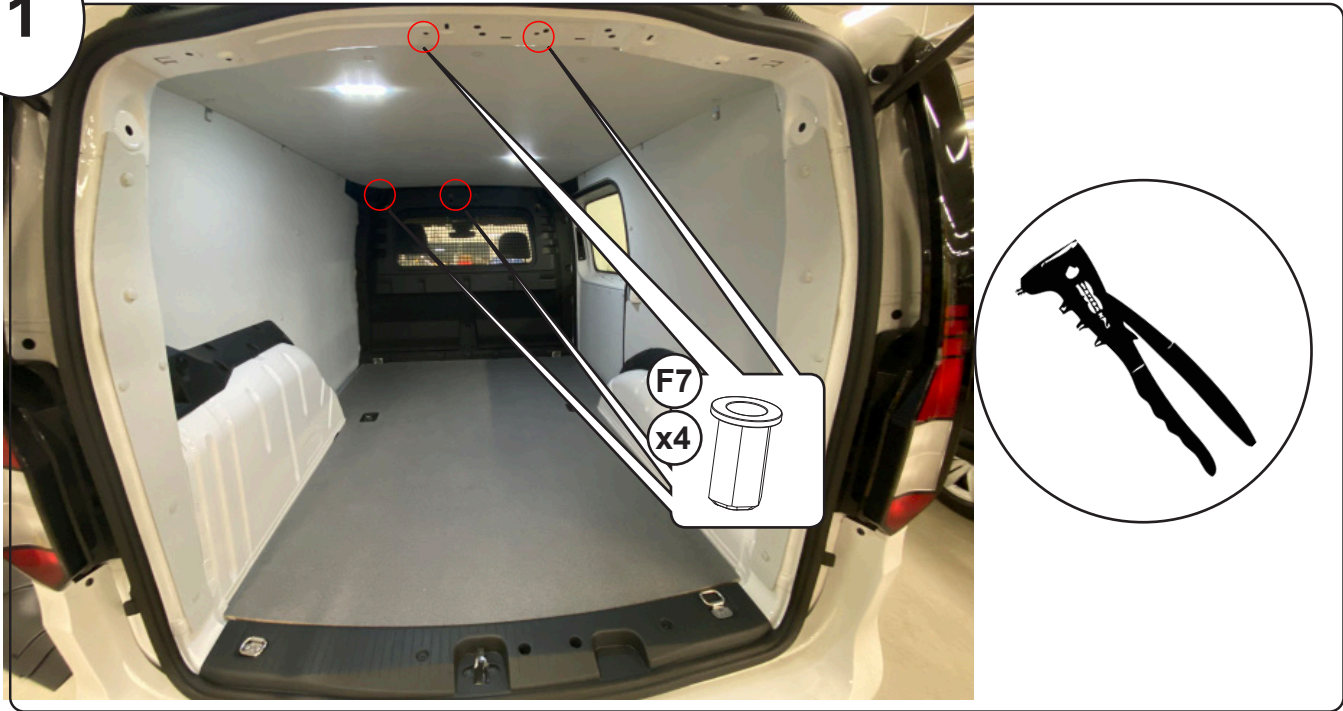

# 2 ROOF BRACKETS - fitting

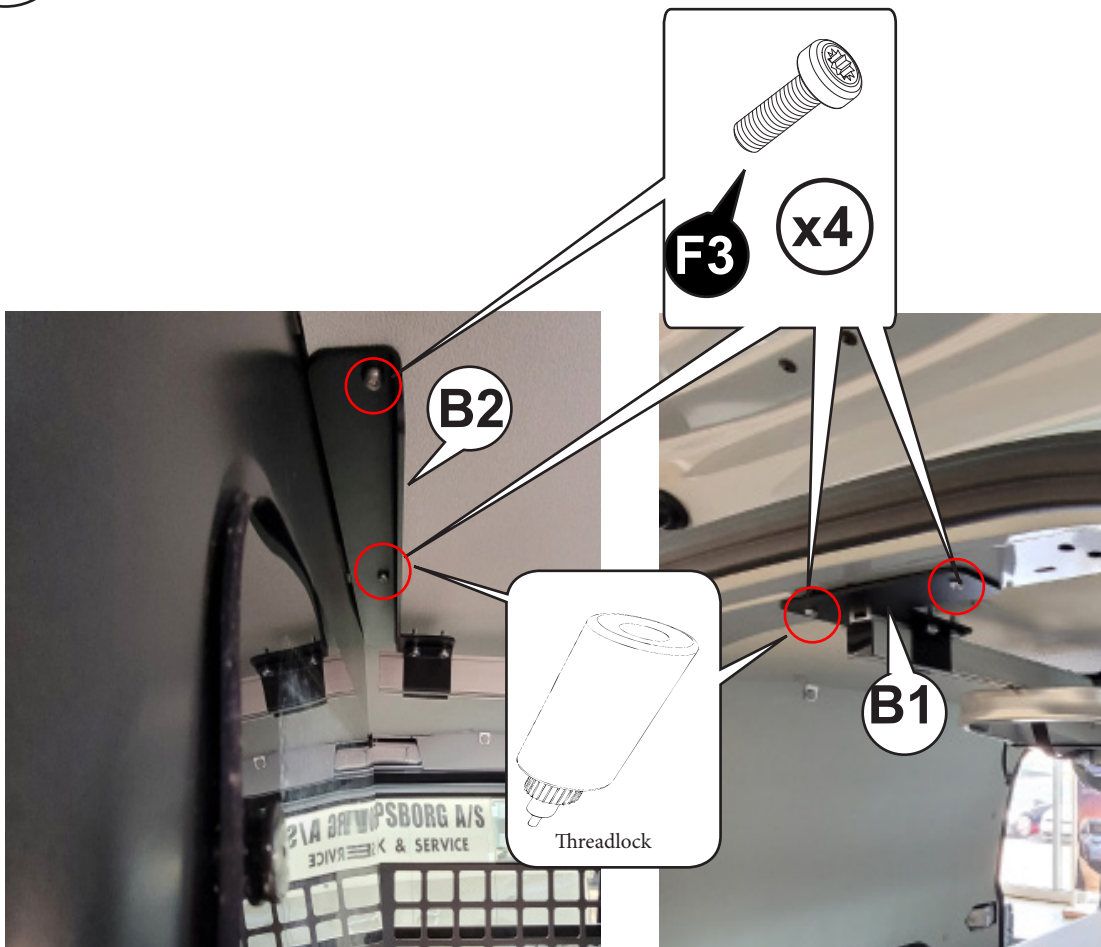



# 2.1

## Front ROOF BRACKETS - fitting with and without roof panel

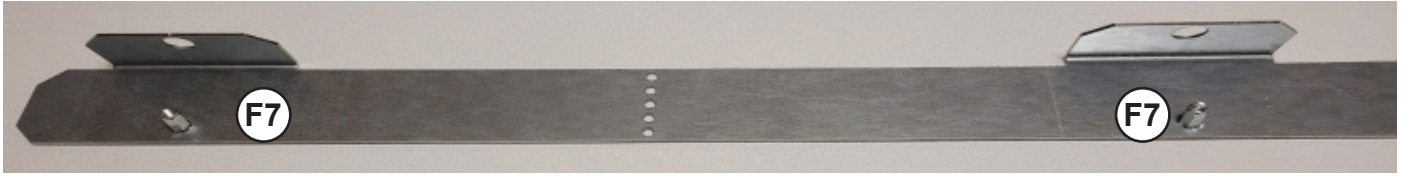

VW original seperator.  
Use 15019094 Roof panel support front, to fastning B2  
(15022093 Roof bracket Front Stepladder).



Loyds Comfort seperator.  
Use 15020247 Roof panel support LH front short for comfortwall, to  
fastning B2 (15021396 Roof bracket Front Stepladder).

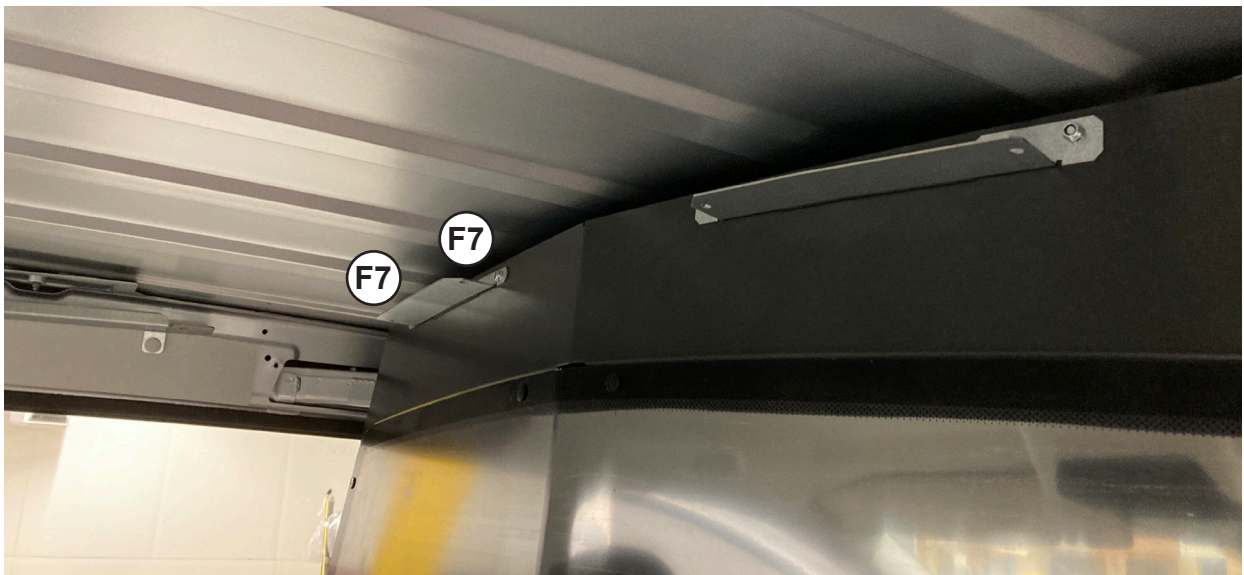

3

### TRACK - preparations

F11

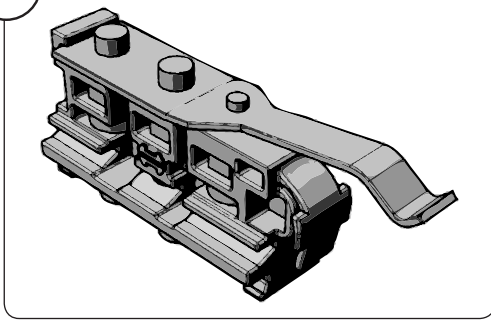

Front

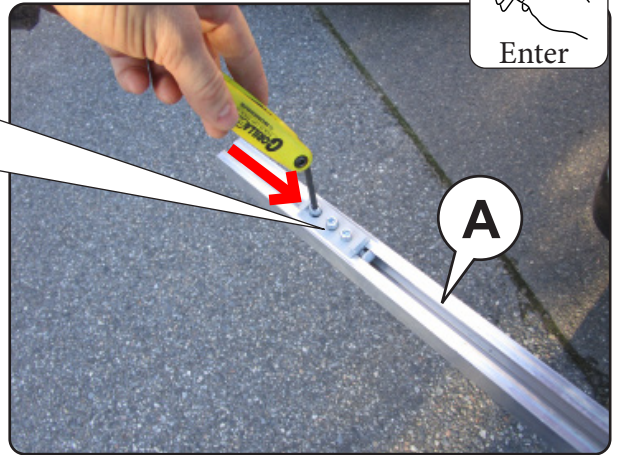

3.1

### TRACK - preparations

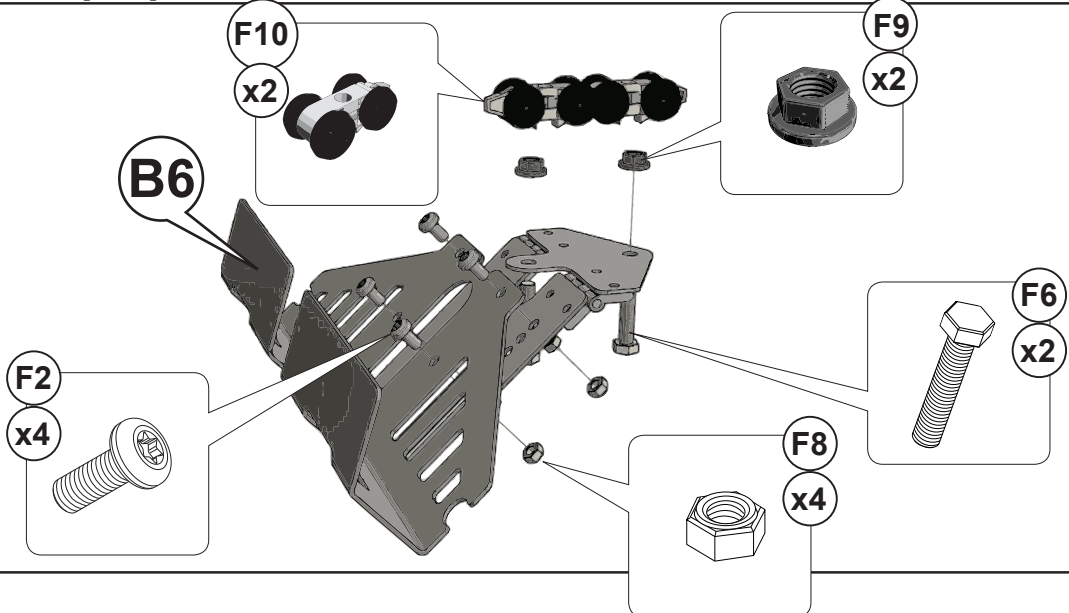

3.2

### TRACK - preparations

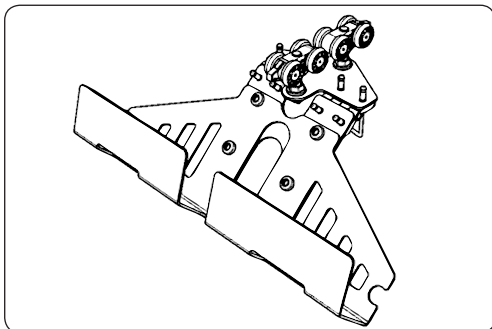

Rear



### 3.3 TRACK - preparations

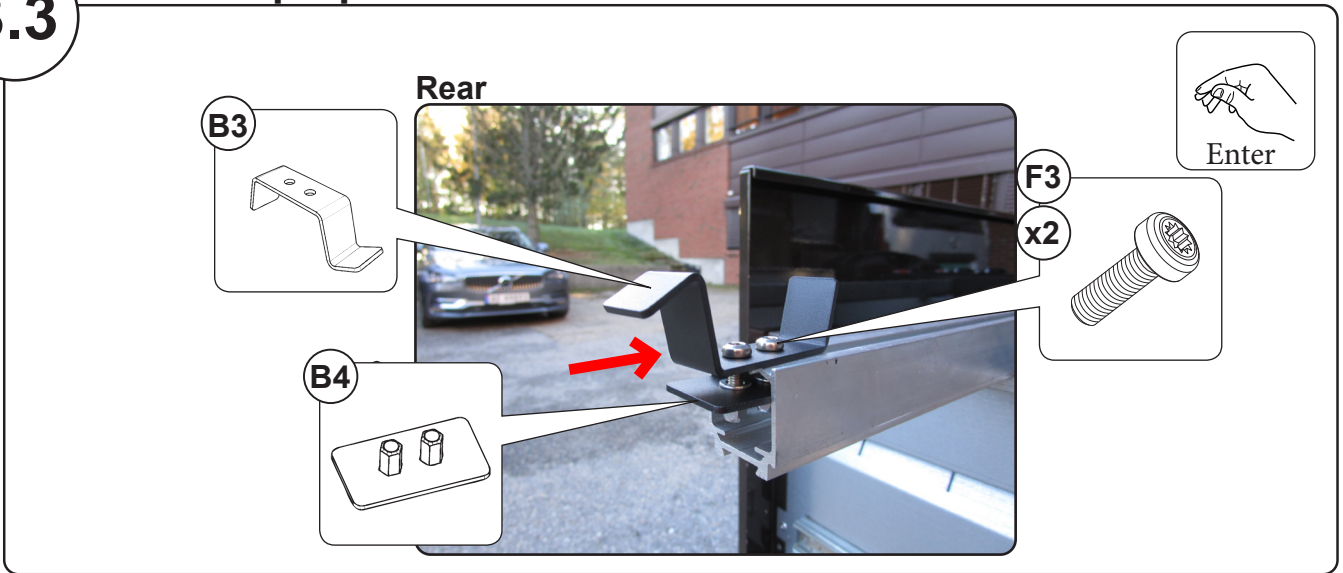

### 3.4 TRACK - preparations

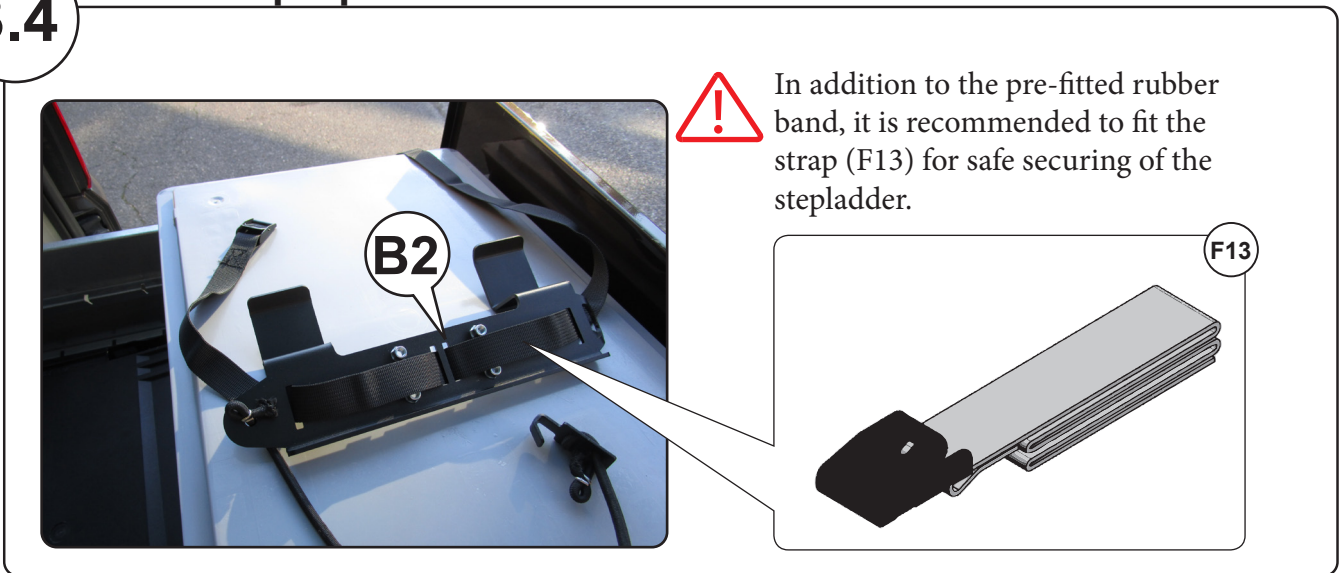

### 3.5 TRACK - preparations

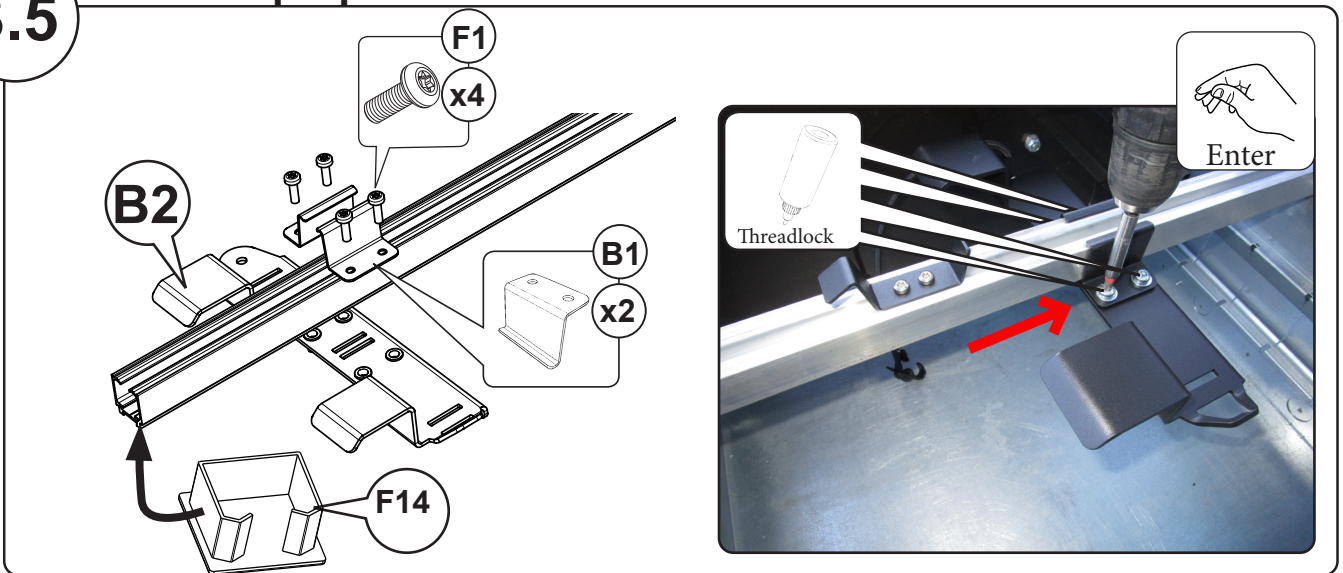

# 3.6 TRACK - preparations

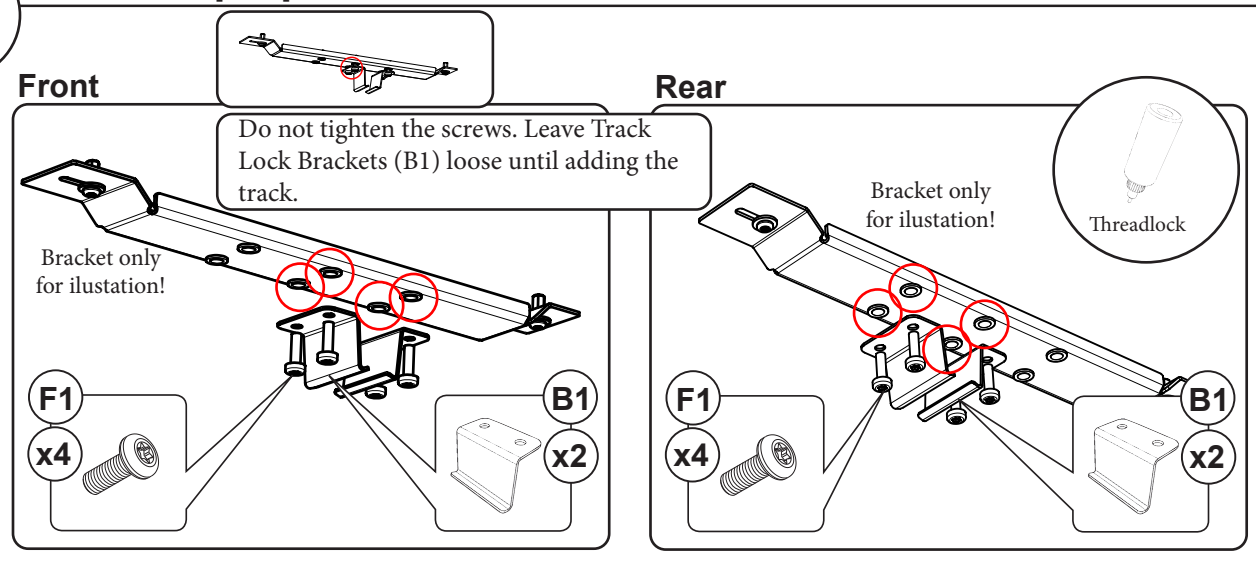

# 4 TRACK - fitting

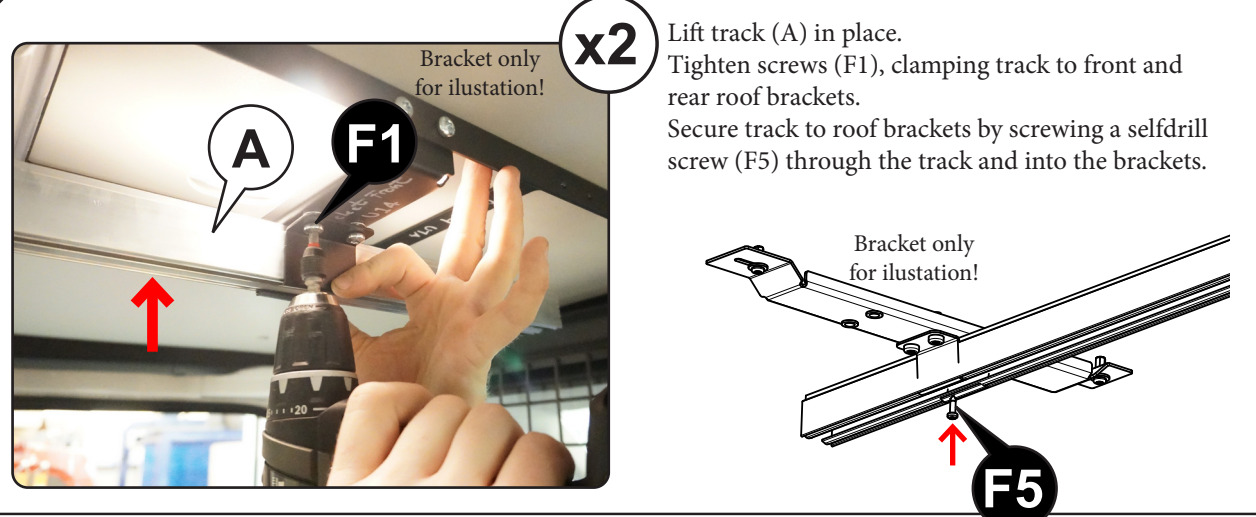

# 5 ADJUSTMENTS - Ladder Stop Bracket

